

USER MANUAL TO CONNECT NEW BLUETOOTH RECEIVER

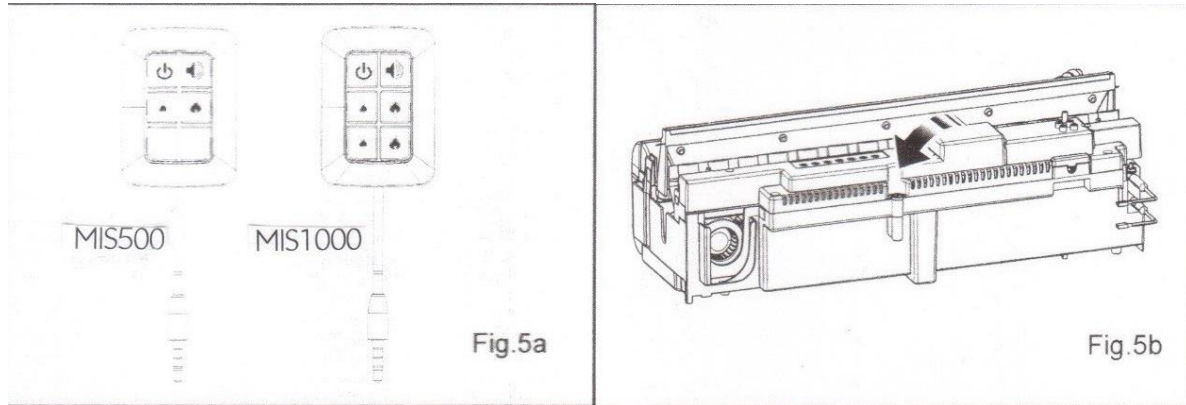

Connect the Bluetooth receiver

Lift off the metal top plate to gain access to the appliance. First remove the old Bluetooth receiver! Take the **new** receiver (4button for Mistero 500 and 6button for Mistero 1000) and insert the 3.5 mm jack into the socket at the back of the appliance (Fig. 5). Please ensure that the jack is inserted far enough (till you hear a click), otherwise the Bluetooth receiver does not work!



The receiver has a cable length of 1.4 mm which allows you position it anywhere around the product. If you prefer to hide it the receiver can be placed inside the surround/wall. Please ensure that the receiver is not enclosed in metal, concrete or any other dense material, this will affect the signal from the remote control.

Now you need to connect the new Bluetooth receiver with your telephone. Follow the following steps:

- The mains switch must be in the “ON” (I) position for the appliance to operate.
- Press on the on/standby button to turn the appliance on (symbol ). Hold the button for a couple of seconds.
- Then press on the Bluetooth button on the appliance to connect (symbol ). The lights start blinking now. This is normal.
- Now press on the on/standby button of the new Bluetooth receiver (symbol ).
- The lights start blinking for three times and the appliance is connected.

Now you can download the Safretti Magic-Fire app on your smartphone on the App Store/Google play.

- If you type “Safretti” in the search-screen (symbol magnifying-glass), the Safretti Magic-Fire app appears.
- Install the app.
- Open the app.
- If you did not switch your telephone on Bluetooth yet, you will see the message below (fig. 1).
- Switch your telephone on Bluetooth.
- Then you see the next message “swipe down to look for devices” (fig. 2 below).
- Swipe down to search for the device.
- If the device has been found, you will see the name “Safretti Magic-Fire” appearing on the screen (see fig. 3 below).

- Please click on “Safretti Magic-Fire” and a checkmark appears in the box. Then please click on the arrow next to “Find & Connect”. Now the appliance can be controlled with the app.

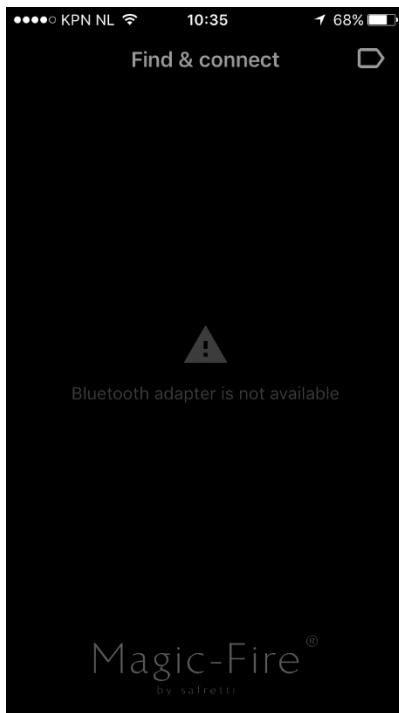

Fig. 1

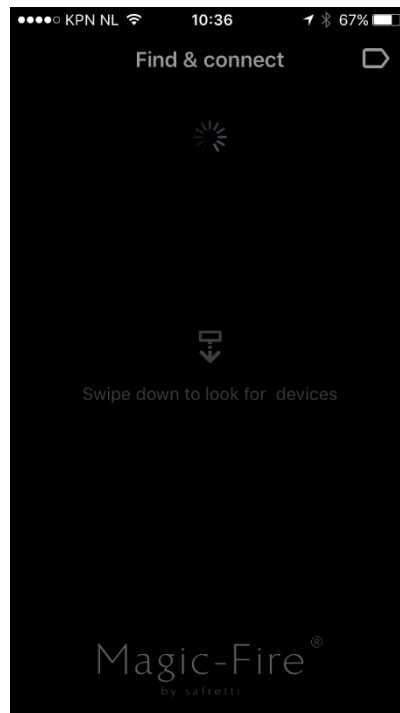

Fig. 2

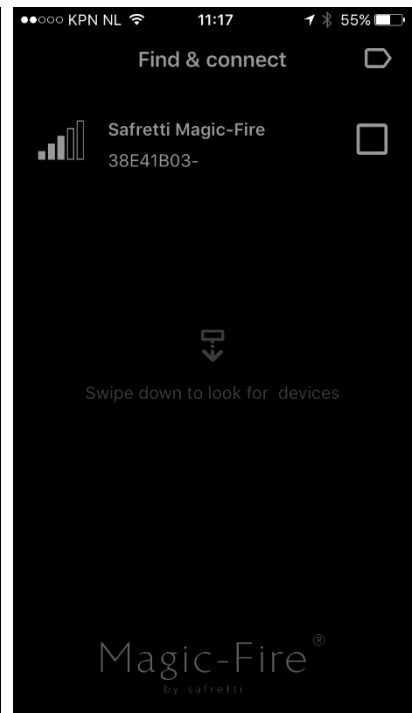

Fig. 3

If you have Mistero 500 and the control panel of Mistero 1000 appears (6button), please click on the “Find & Connect” symbol at the top of the screen (arrow next to Find & Connect). Now the control panel of Mistero 500 appears (4button).

If you have Mistero 1000 and the control panel of Mistero 500 appears (4button), please click on the “Find & Connect” symbol at the top of the screen (arrow next to Find & Connect). Now the control panel of Mistero 1000 appears (6button).

Attention: it is not possible to connect several smartphones or tablets with the appliance at the same time. You first have to log-out (see fig. 3: click on the name “Safretti Magic-Fire”, so the checkmark disappears) to be able to connect another smartphone or tablet.